

Pracovní listy úvodních projektů

s robotickou stavebnicí Robo Wunderkind



Projekt 1: Seznamte se s Robem!



Dnes máme v naší třídě speciálního hosta! Je to Robo, chytrý robot, který chce být naším kamarádem a pomáhat nám s různými úkoly. Myslíte si, že se Robo může učit společně s námi?

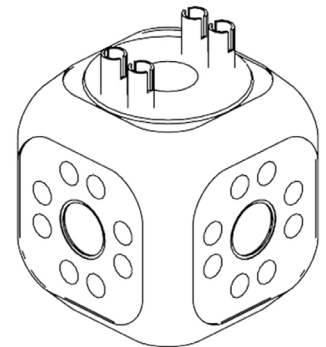
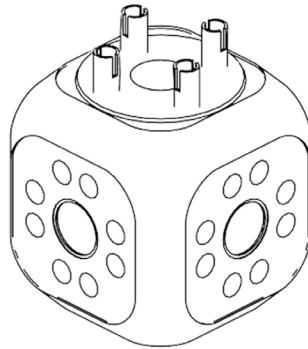
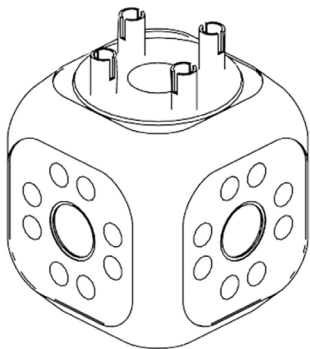
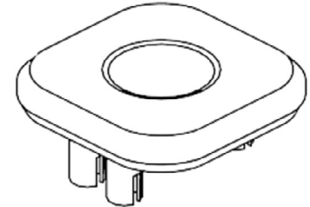
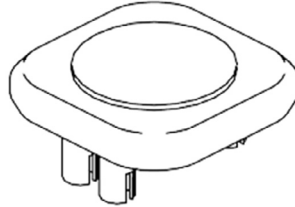
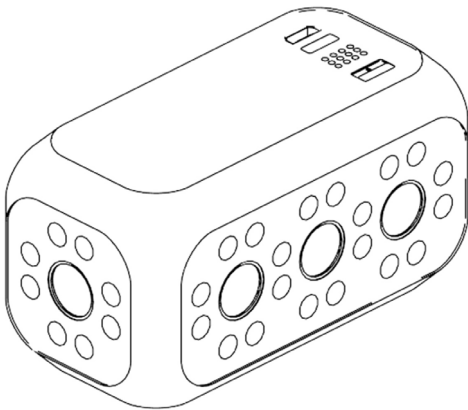

Abychom se s Robem seznámili, staneme se inženýry a sestavíme si prvního robota!

1**Moduly Robo: Barva, velikost, tvar.**

2 Moduly Robo: Konektory a kolečka

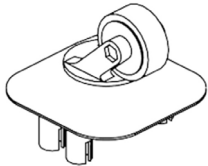
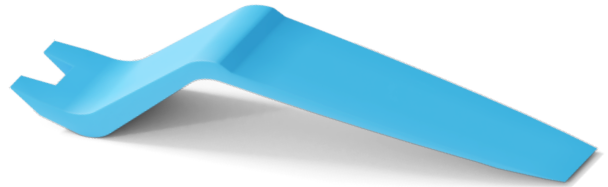
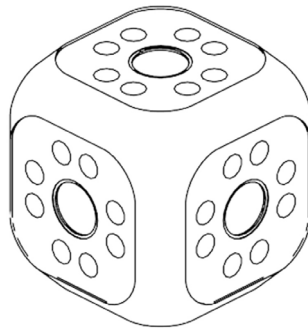
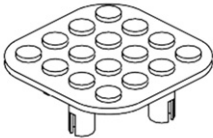
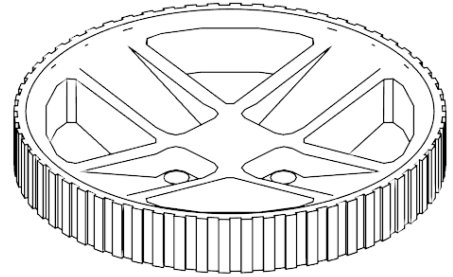
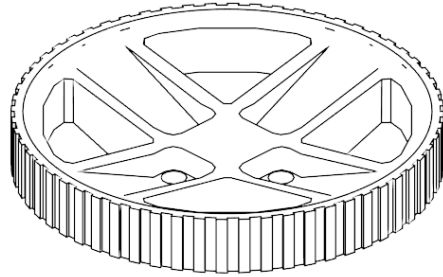
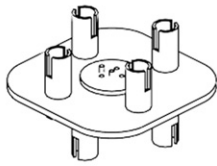

3 Můj první Robo

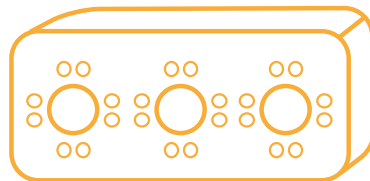

Dobrá práce!



Projekt 2: Robo jako syntezátor!



Robo miluje hudbu a jeho hlavní oranžový blok umí hrát!



Přeměňte Robo na syntezátor a přehrávejte na něm hudbu!

1

 Hudba 



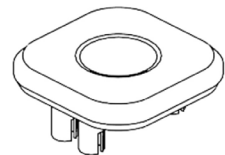
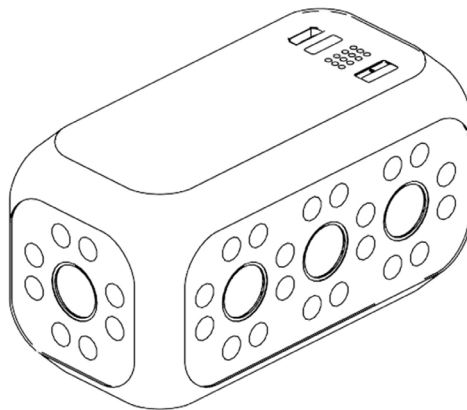
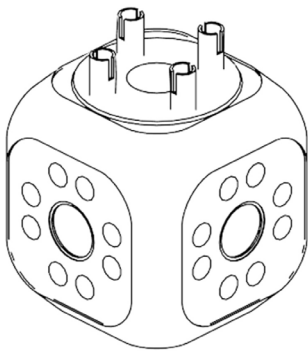

2

 Robův mozek



3   Můj Robo syntezátor

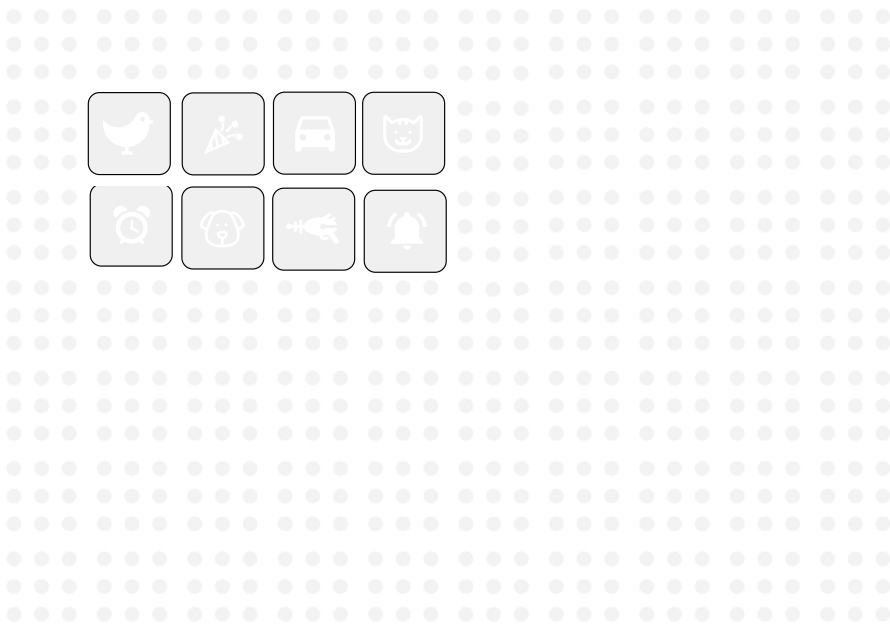

4  Moje oblíbené zvuky



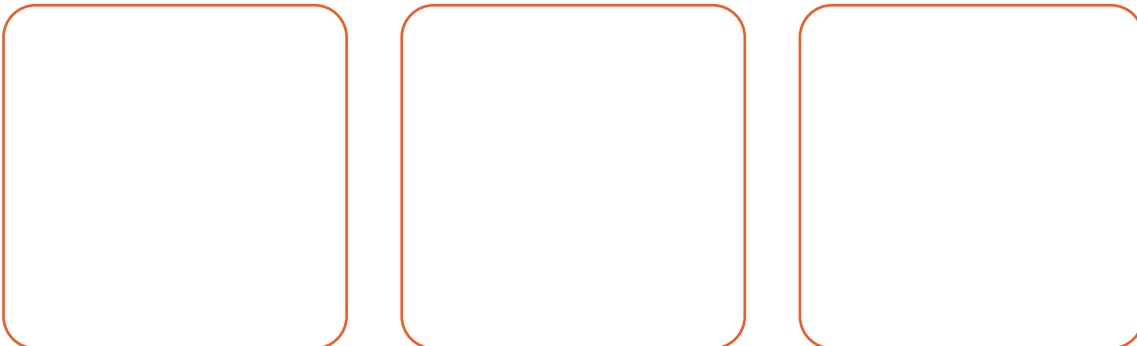

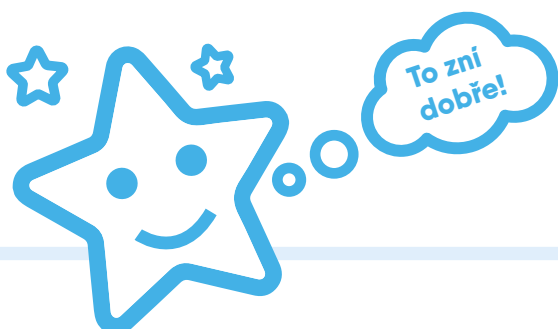
Projekt 3: Robo jako barevné noční světlo



Někteří roboti v noci spí, takže se před tím připravují na noc – stejně jako vy! Můžeme si proto díky Robo sestrojít barevné noční světlo a mít tak hezké a barevné sny.

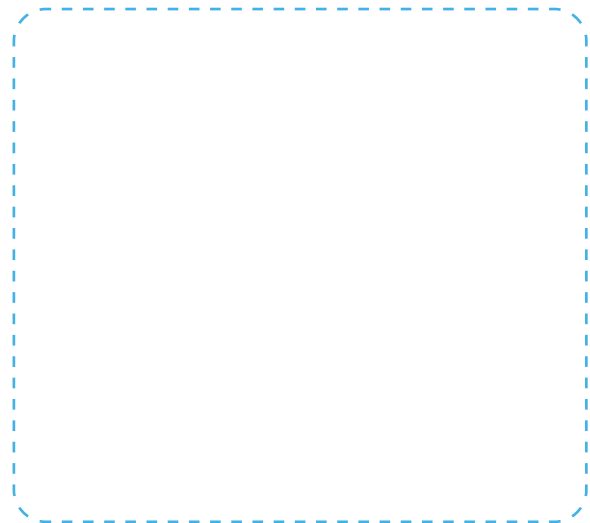
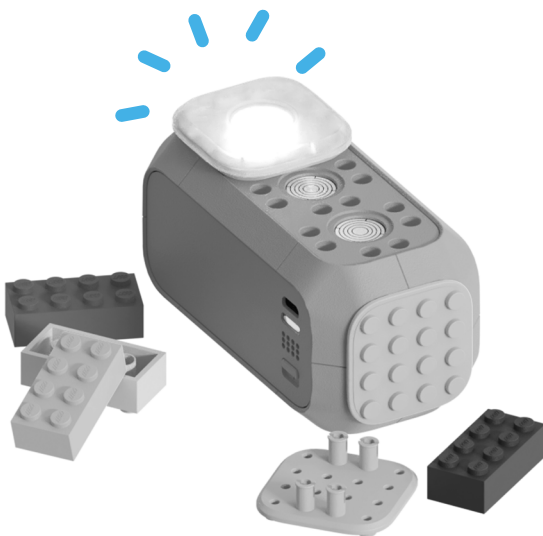

Sestavte si robotické barevné noční světlo a vytvořte si před spaním příjemné prostředí.

1**Večerka****2****Robo světlo**

3 Moje barevné noční světlo

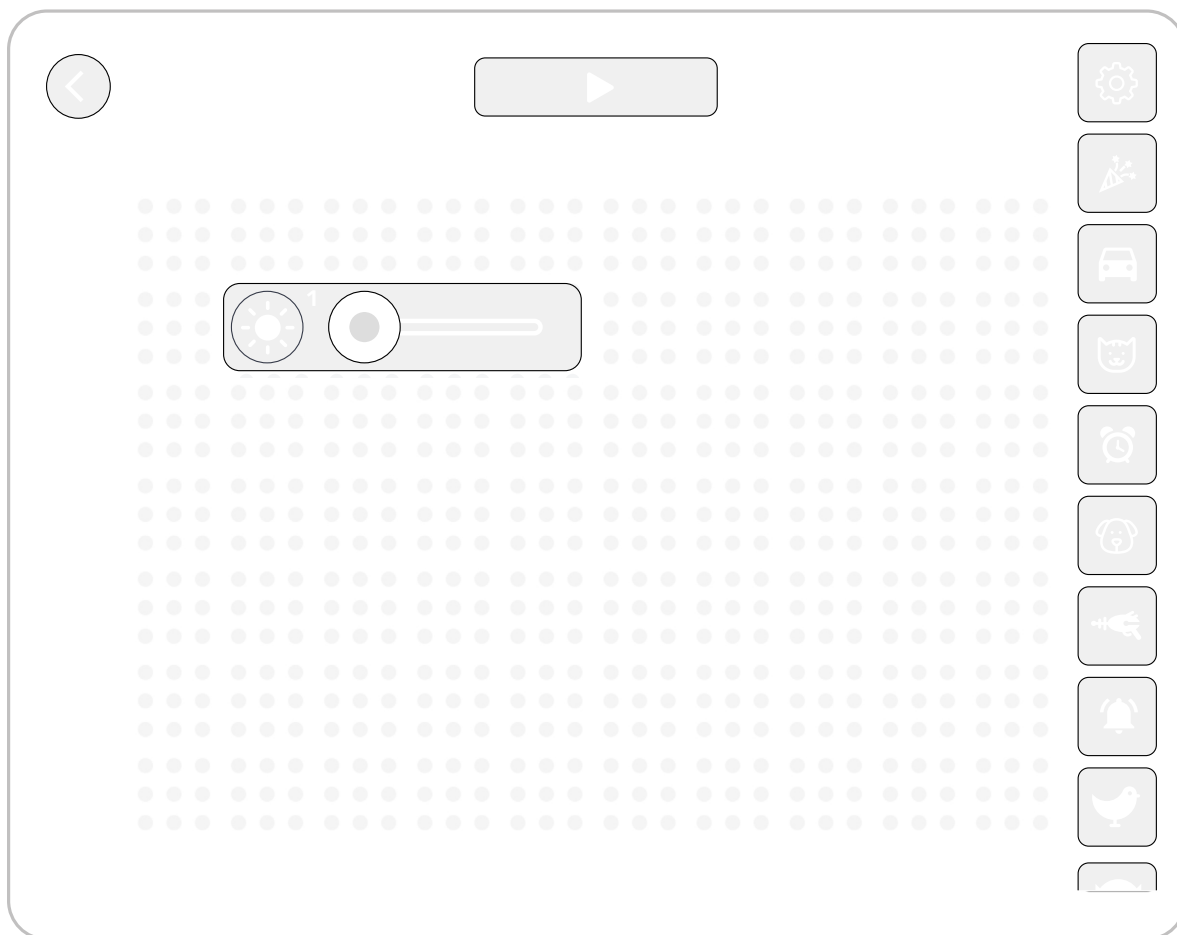

4 Moje oblíbené barvy

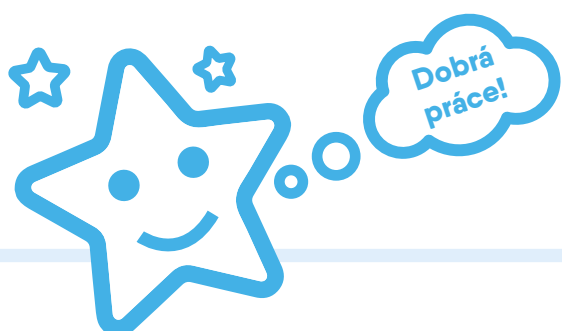

Projekt 4: Robo jako větrák



V naší třídě je takové horko. Jak můžeme trochu ochladit vzduch? Jak víte, náš kamarád Robo se umí proměnit v různé roboty, jak nám může pomoci?



Sestavte robotický větrák, který ochlazuje vzduch.

1 Robo větrák: Moduly

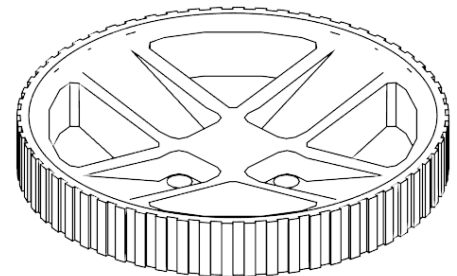
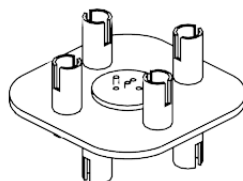
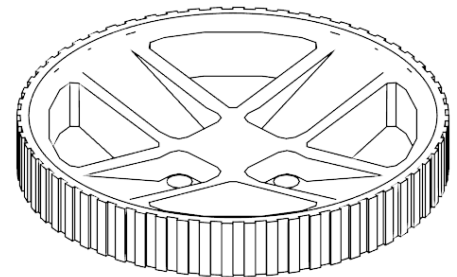
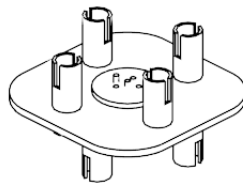
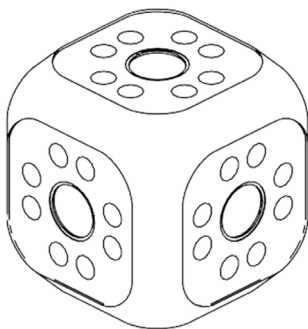
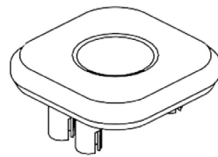
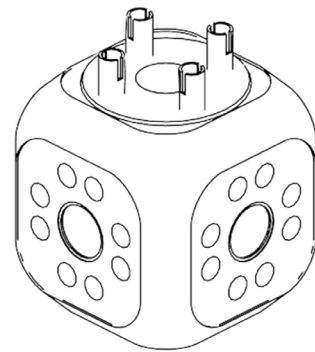
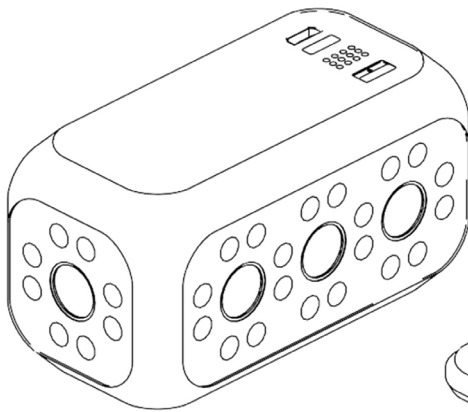

2 Postav Robo větrák

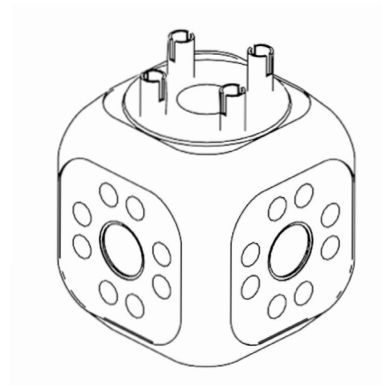

3 Můj Robo větrák

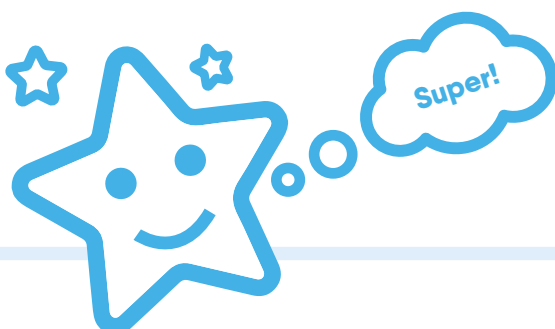
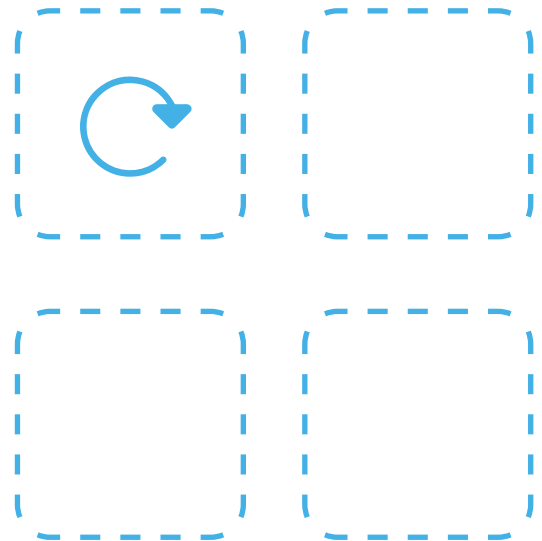
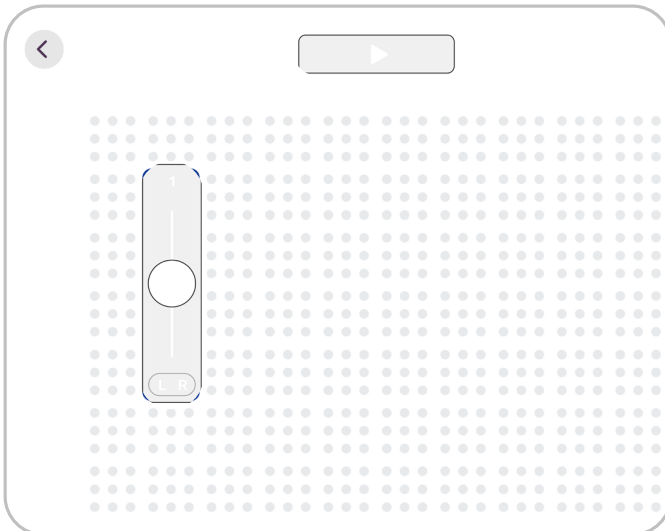

Projekt 5: Robo jako auto



Robo je velmi zvědavý tvor, který rád objevuje svět kolem sebe! Robo chce cestovat, ale nejdřív musí umět řídit! Dokážeme postavit Robo-auto?



Postavte Robo-auto, které bude jezdit po okolí.

1



Robo auto: Motory

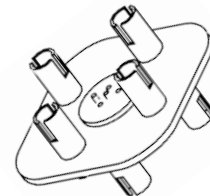
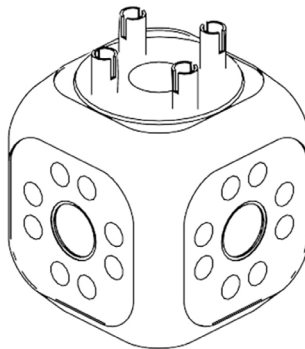
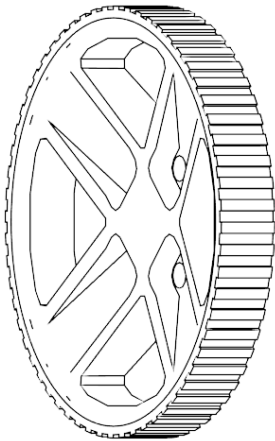
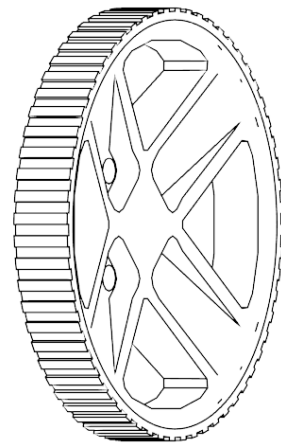
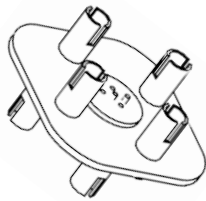

2  Postavte Robo auto

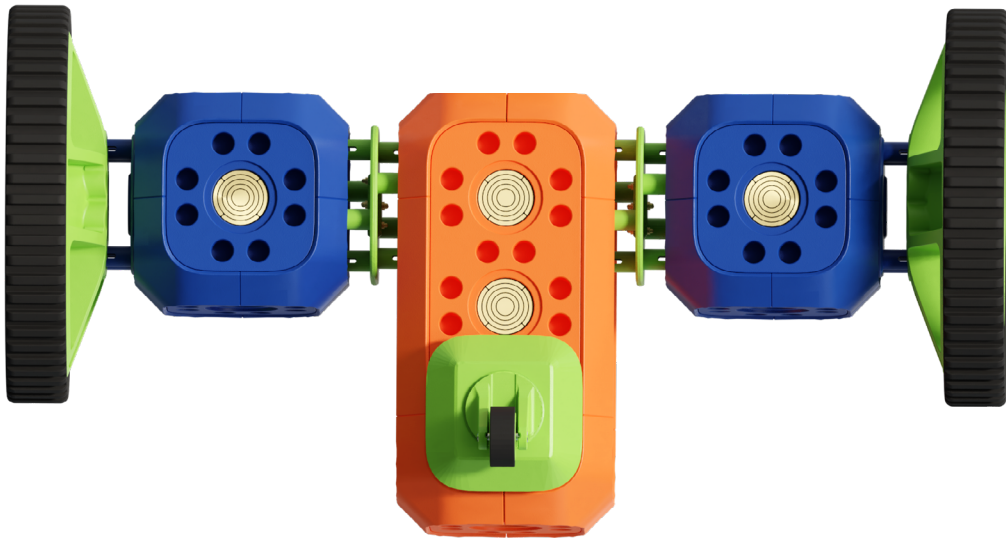

3  /  Ovládejte jízdu Robo auta

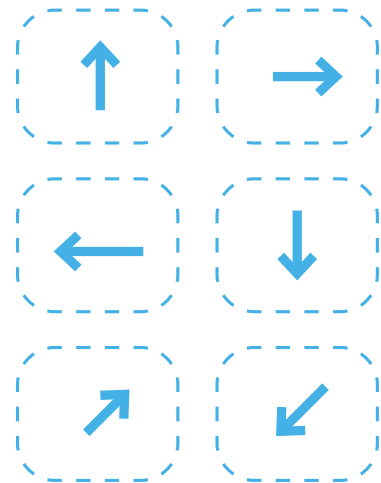
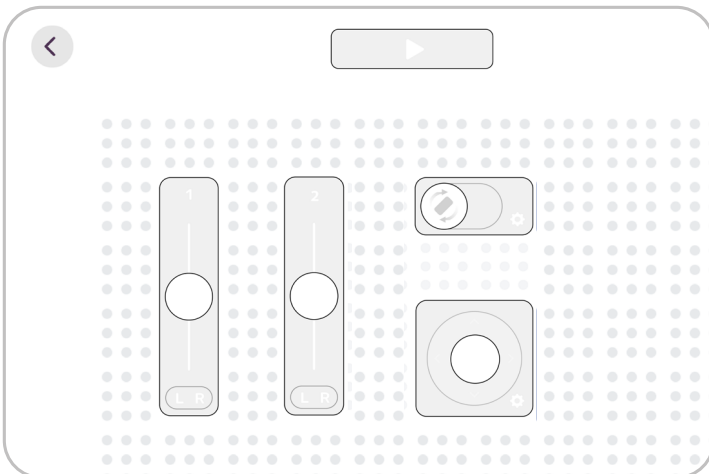

4  Zaznamenejte jízdu svého Robo auta

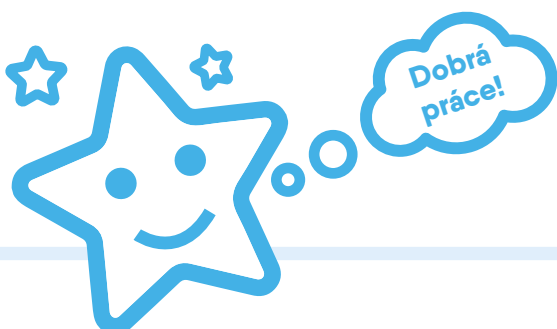
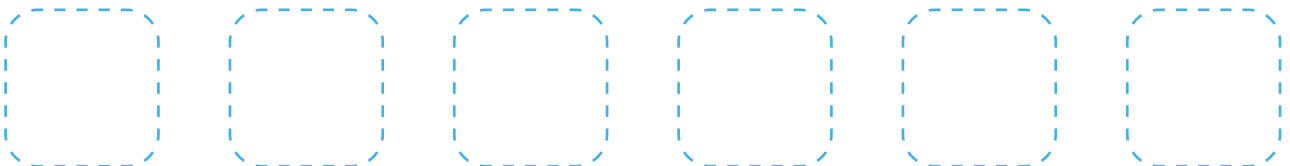

Projekt 6: Robo cestuje do města hraček



Dnes ráno dostal Robo dopis od ostatních hraček, které žijí ve městě hraček. Pozvaly ho, aby navštívil město a seznámil se s novými kamarády. Robo se na svou první cestu do města hraček velmi těší, ale je trochu nervózní... Můžeme Robo pomoci, aby mohl cestovat do města hraček?



Sestavte robotické vozidlo, které dokáže navštívit město hraček a najít si přátele!

1 Robo cestovatel: moduly



2 Město hraček



3 Robo cestuje do města hraček

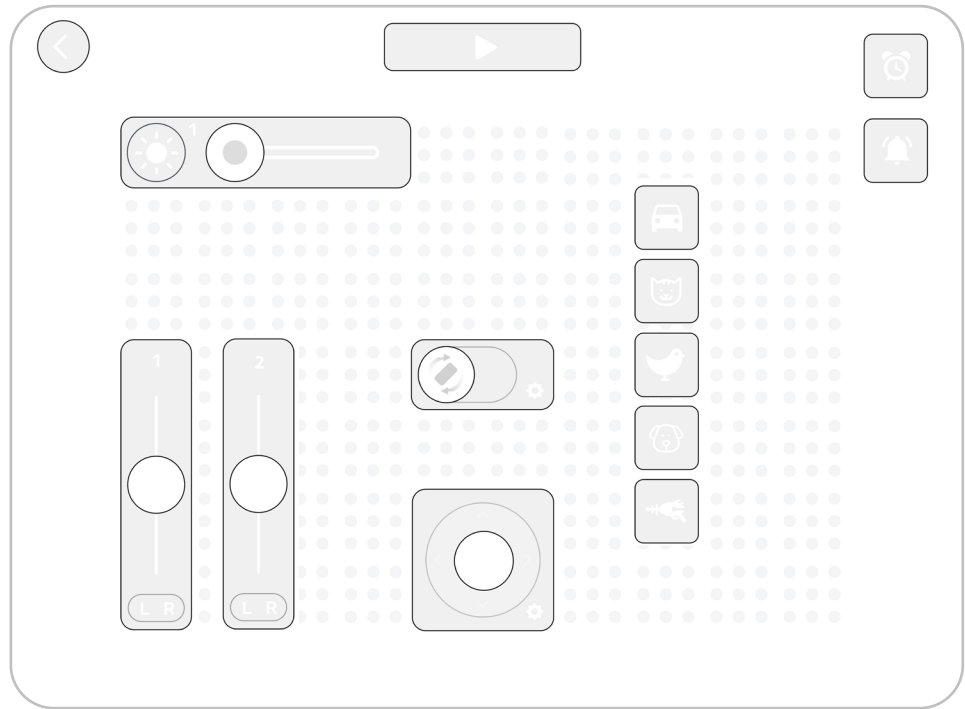
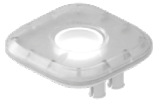

4 Můj Robo cestovatel

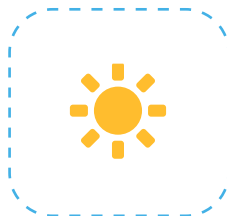
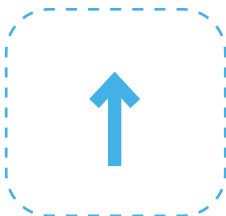

Projekt 7: Robo se rozhlíží

 Nyní má náš Robo ve městě hraček přátele a rád by s nimi více komunikoval. Jak my jako lidé komunikujeme? Můžeme postavit robota, který dokáže otáčet hlavou?

 Sestavte robota s hlavou a naučte ho, jak se rozhlížet a komunikovat s ostatními hračkami!

1 Pohyby těla



2 Robo hlava: Moduly

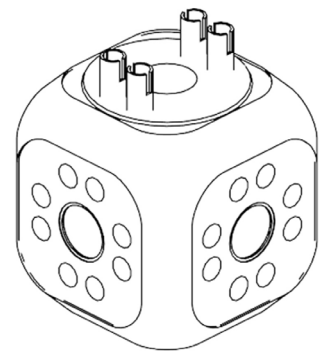

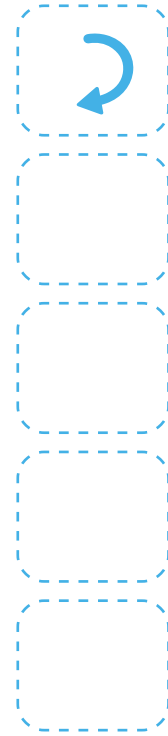
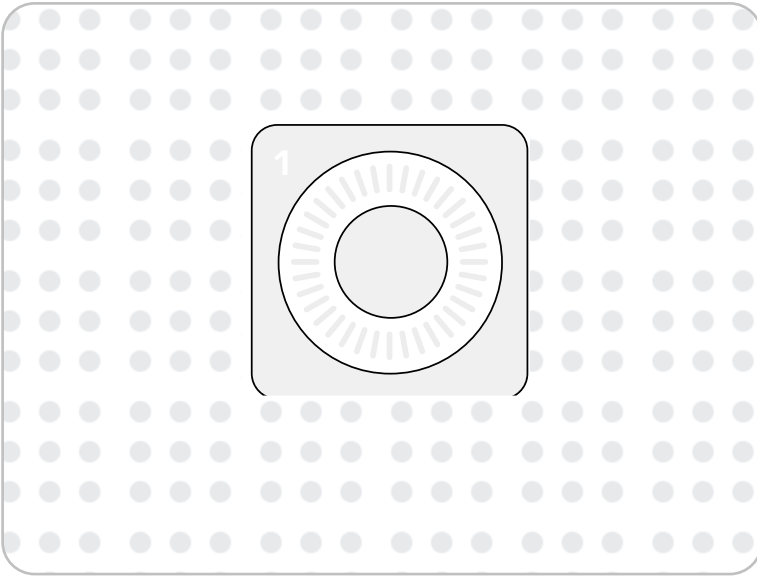

3   Robo otáčí hlavou

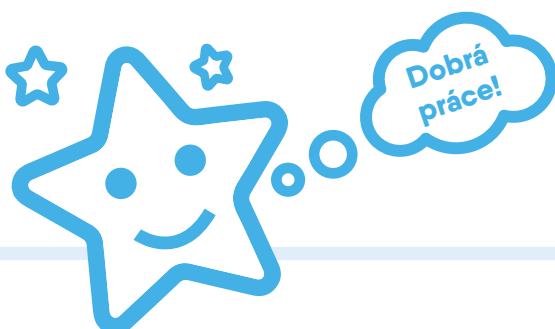
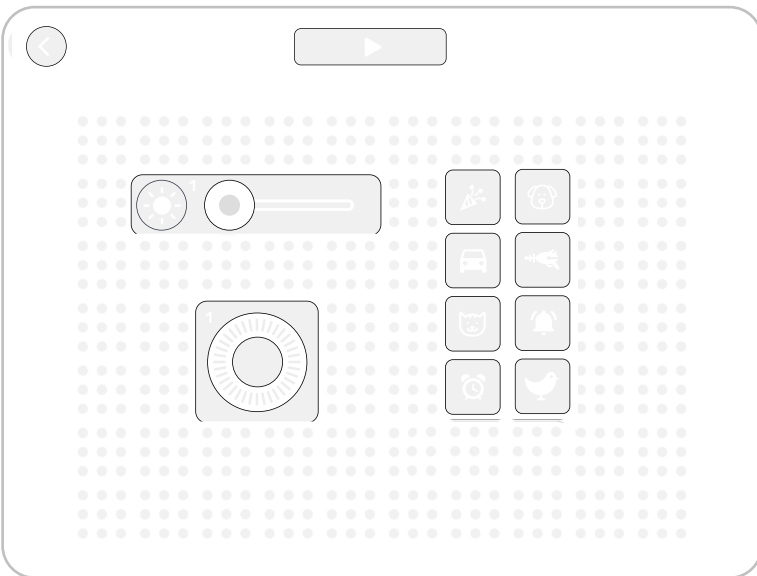

4  /   Co všechno umí můj Robo?



Projekt 8: Robo je strážce

-  Obyvatelé města hraček požádali Robo, aby jim pomohl udržet bezpečí v ulicích a stát se strážcem. Co by měl Robo-strážce dělat?
-  Sestavte Robo-strážce, který pomáhá hračkám ve městě udržovat ulice v bezpečí.

1 Robo moduly

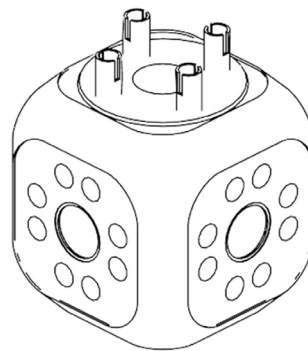
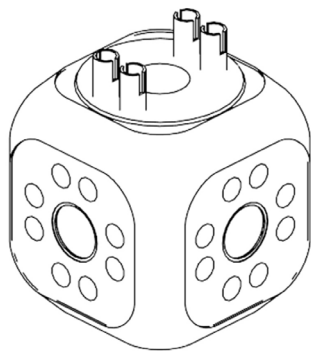

2 Jak se Robo pohybuje?

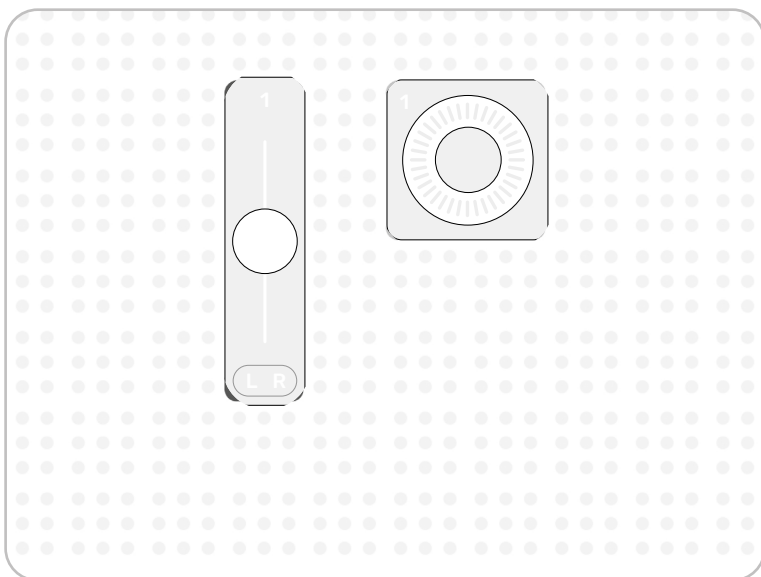

3 / Robo a jeho ovladače

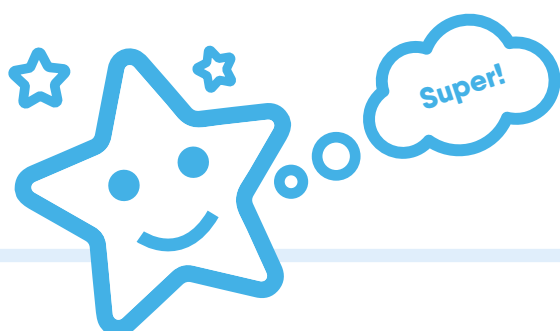
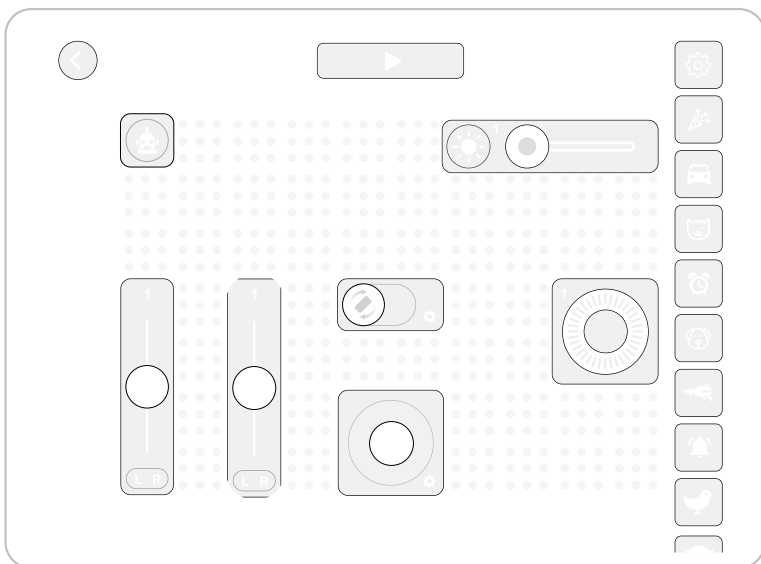

Projekt 9: Robo jako domácí mazlíček



Někteří lidé nemohou mít domácího mazlíčka z mnoha různých důvodů. V dnešním moderním životě se mohou roboti změnit v různé tvory – mohou se dokonce stát chytrými robotickými mazlíčky! Chtěli byste si hrát s robotickým mazlíčkem?



Sestavte robotického mazlíčka pomocí všech modulů, které jsme se naučili a naučte ho být naším přítelem.

1 Robo zvířátko

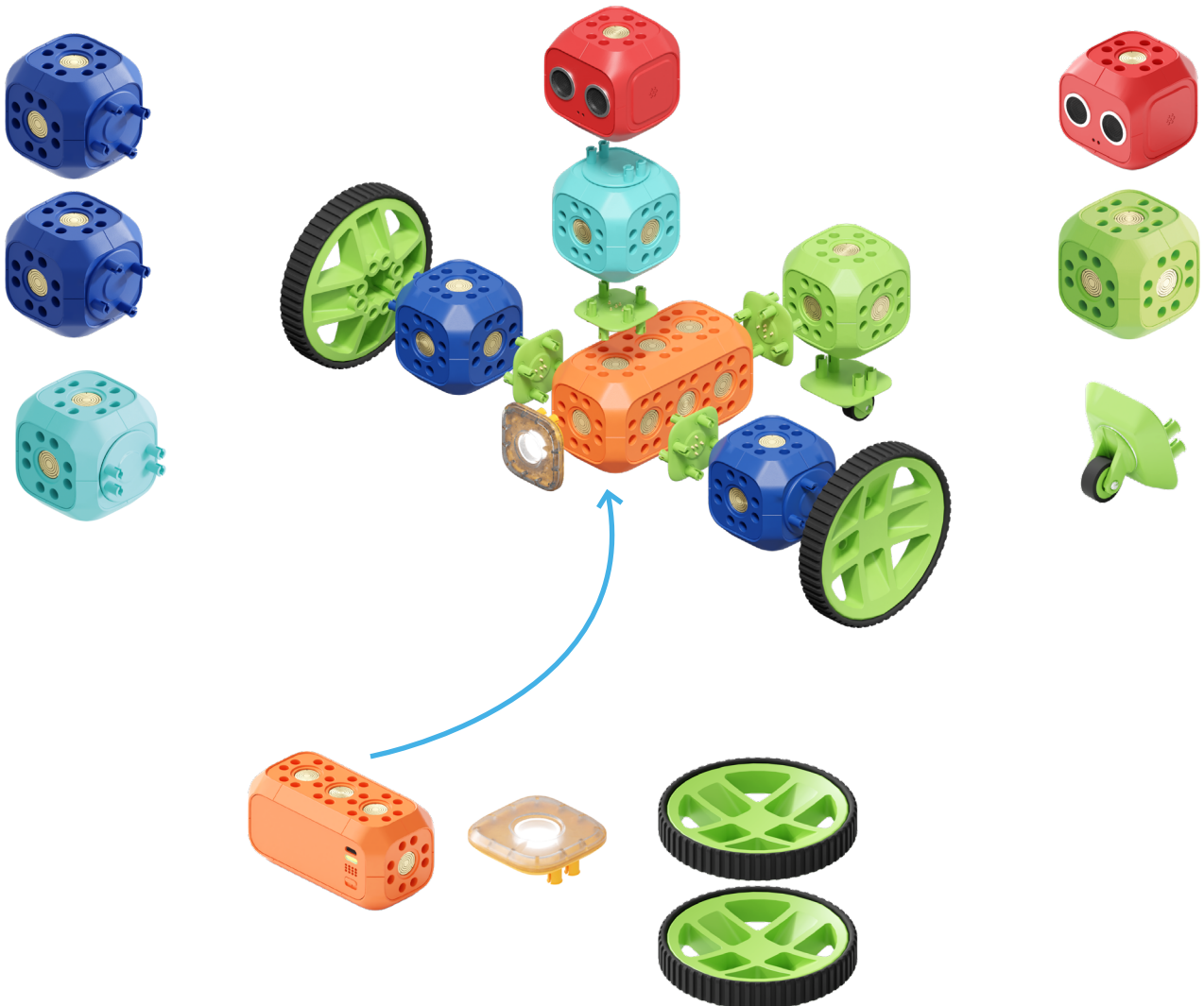

2 Hraj si se svým Robo zvířátkem



3 / Moje Robo zvířátko

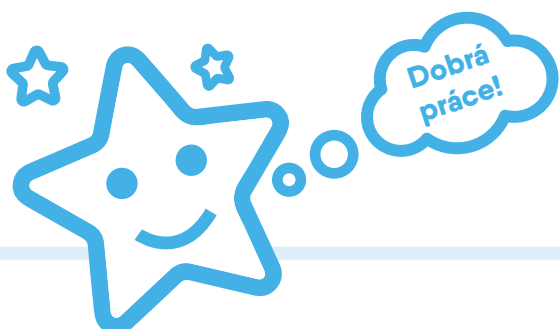
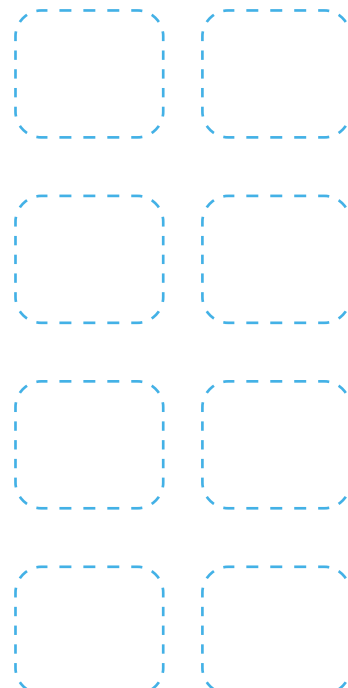
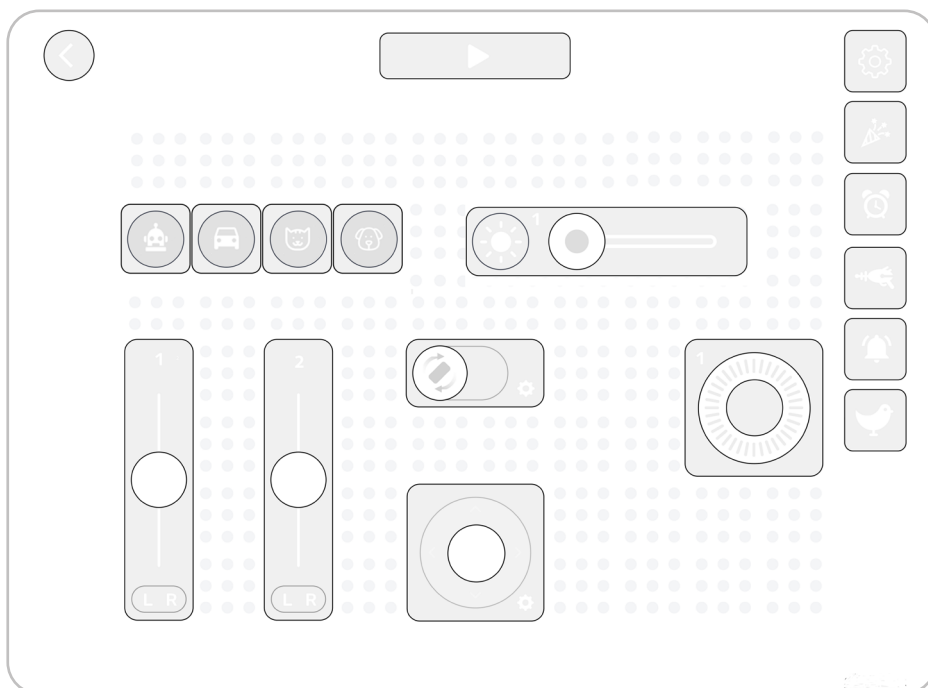

Projekt 10: Čím bude tvůj Robo?



Nyní je řada na vás, abyste se rozhodli, v které zařízení nebo postavu byste chtěli, aby se váš Robo proměnil! Musíme také vymyslet důvod, proč potřebujeme právě toto Robo zařízení nebo postavu a umět vysvětlit, jak nám pomůže!



Sestavte vlastní Robo-projekt a vymyslete k němu příběh.

1 Můj Robo: Příběh a jméno

2 Můj Robo: Moduly

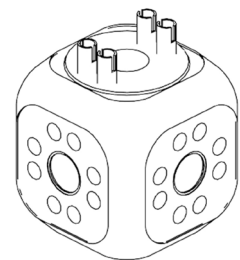
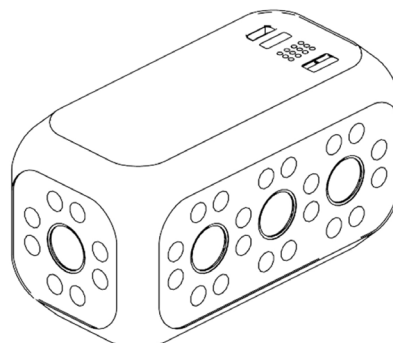
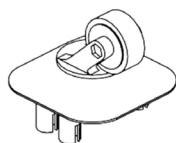
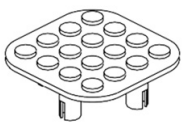
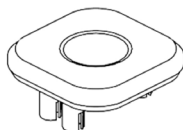
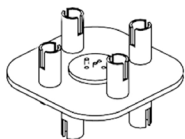
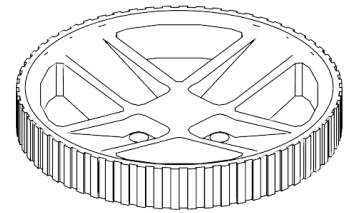
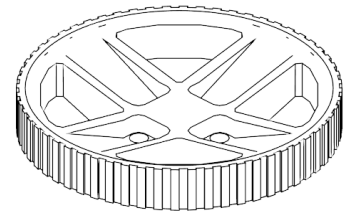
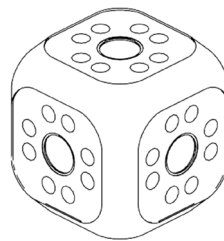
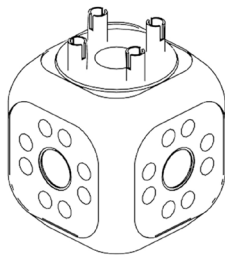
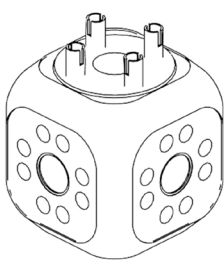

3



Co dokáže můj Robo?

